



Model 88 V Automotive Multimeter Quick Reference Guide

 See *Users Manual* for "Safety Information" and complete operating information.

Fuse Test

 + LEAd =  OK

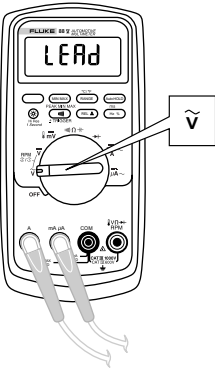

Test Lead Alert

 + LEAd = 

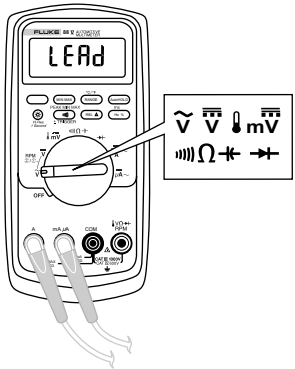

Voltage \tilde{V} $\bar{\bar{V}}$ $\bar{\bar{mV}}$

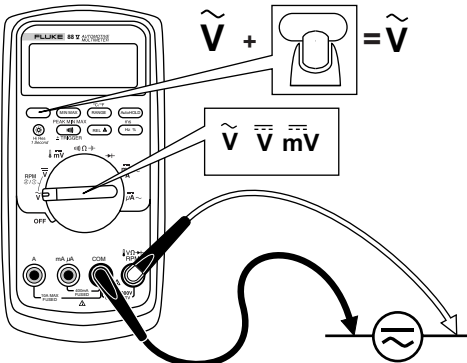

Temperature

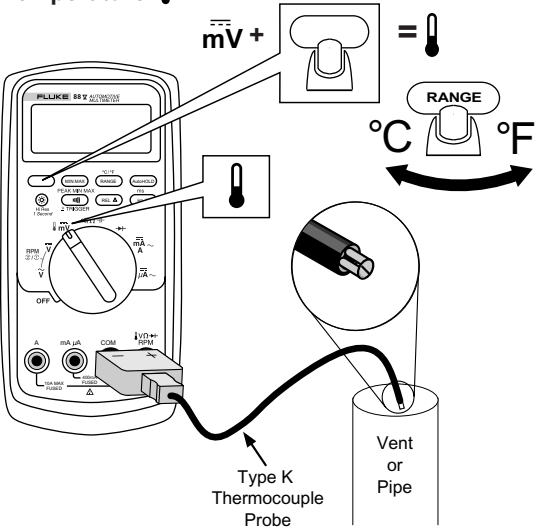

Resistance Ω

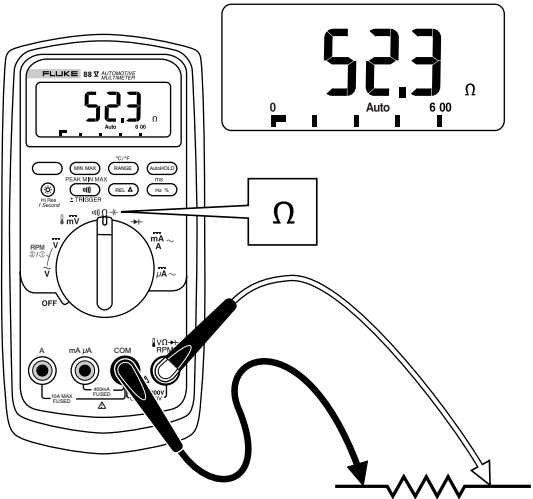

Conductance nS

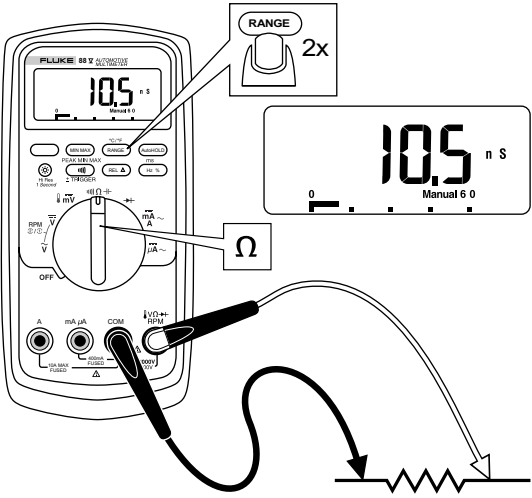

Continuity

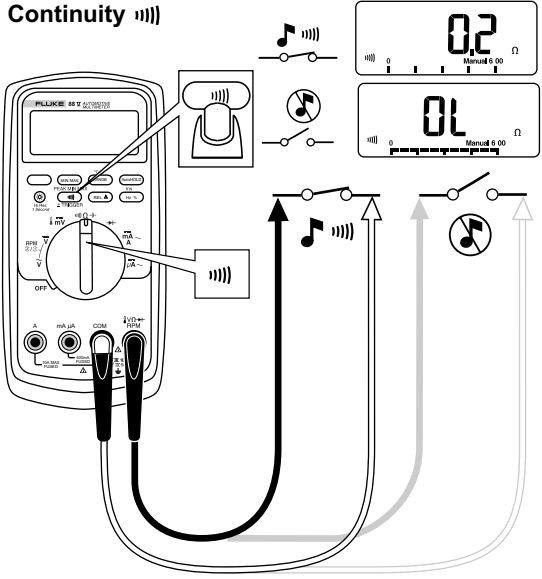

Smoothing (Power Up Option Only)

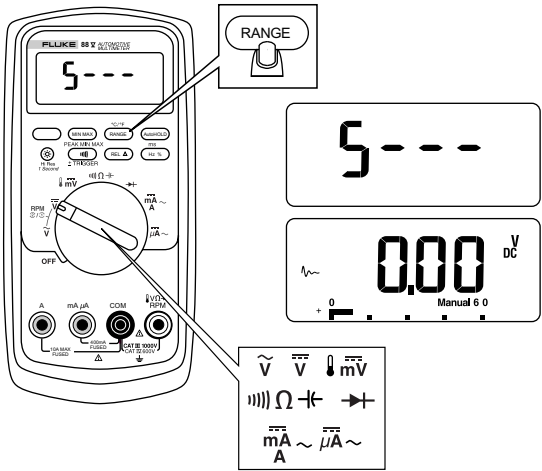

Current \bar{mA} , \tilde{A} , $\bar{\mu A}$, \bar{mA} , \bar{A} , $\bar{\mu A}$

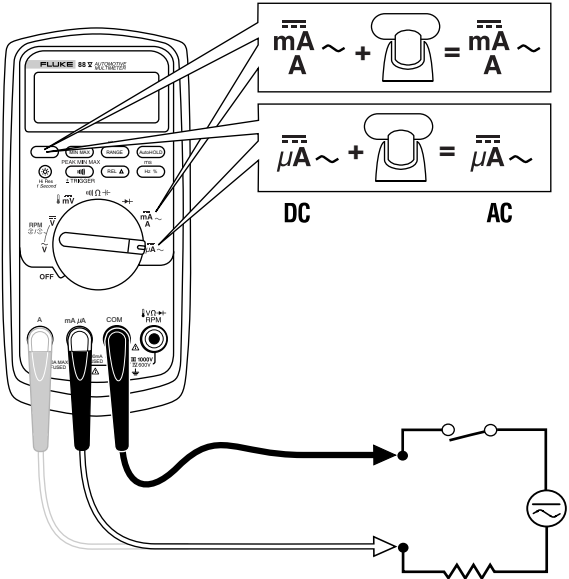

Diode Test →

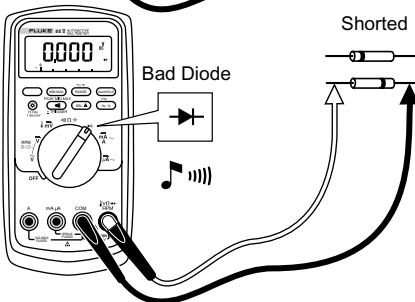
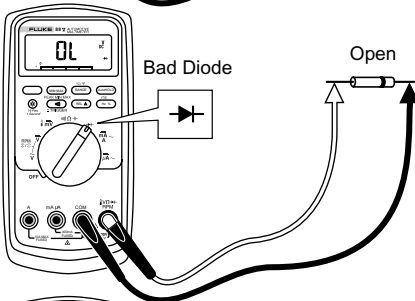
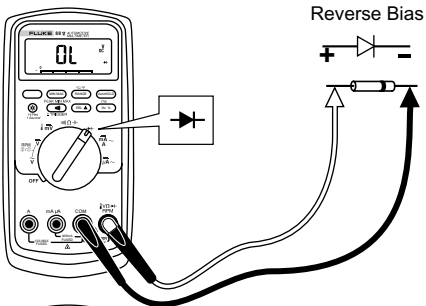
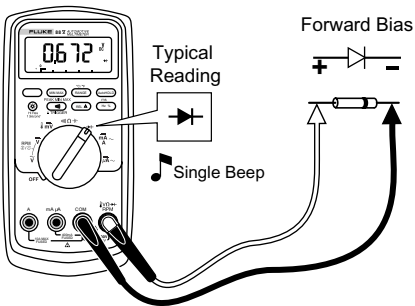

| DUTY CYCLE (%) | DWELL (NO. OF CYLINDERS) | | | | | DUTY CYCLE (%) | DWELL (NO. OF CYLINDERS) | | | | |
|----------------|--------------------------|------|------|------|------|----------------|--------------------------|------|------|------|------|
| | 3 | 4 | 5 | 6 | 8 | | 3 | 4 | 5 | 6 | 8 |
| 0 | 0.0 | 0.0 | 0.0 | 0.0 | 0.0 | 50 | 60.0 | 45.0 | 36.0 | 30.0 | 22.5 |
| 1 | 1.2 | 0.9 | 0.7 | 0.6 | 0.5 | 51 | 61.2 | 45.9 | 36.7 | 30.6 | 23.0 |
| 2 | 2.4 | 1.8 | 1.4 | 1.2 | 0.9 | 52 | 62.4 | 46.8 | 37.4 | 31.2 | 23.4 |
| 3 | 3.6 | 2.7 | 2.2 | 1.8 | 1.4 | 53 | 63.6 | 47.7 | 38.2 | 31.8 | 23.9 |
| 4 | 4.8 | 3.6 | 2.9 | 2.4 | 1.8 | 54 | 64.8 | 48.6 | 38.9 | 32.4 | 24.3 |
| 5 | 6.0 | 4.5 | 3.6 | 3.0 | 2.3 | 55 | 66.0 | 49.5 | 39.6 | 33.0 | 24.8 |
| 6 | 7.2 | 5.4 | 4.3 | 3.6 | 2.7 | 56 | 67.2 | 50.4 | 40.3 | 33.6 | 25.2 |
| 7 | 8.4 | 6.3 | 5.0 | 4.2 | 3.2 | 57 | 68.4 | 51.3 | 41.0 | 34.2 | 25.7 |
| 8 | 9.6 | 7.2 | 5.8 | 4.8 | 3.6 | 58 | 69.6 | 52.2 | 41.8 | 34.8 | 26.1 |
| 9 | 10.8 | 8.1 | 6.5 | 5.4 | 4.1 | 59 | 70.8 | 53.1 | 42.5 | 35.4 | 26.6 |
| 10 | 12.0 | 9.0 | 7.2 | 6.0 | 4.5 | 60 | 72.0 | 54.0 | 43.2 | 36.0 | 27.0 |
| 11 | 13.2 | 9.9 | 7.9 | 6.6 | 5.0 | 61 | 73.2 | 54.9 | 43.9 | 36.6 | 27.5 |
| 12 | 14.4 | 10.8 | 8.6 | 7.2 | 5.4 | 62 | 74.4 | 55.8 | 44.6 | 37.2 | 27.9 |
| 13 | 15.6 | 11.7 | 9.4 | 7.8 | 5.9 | 63 | 75.6 | 56.7 | 45.4 | 37.8 | 28.4 |
| 14 | 16.8 | 12.6 | 10.1 | 8.4 | 6.3 | 64 | 76.8 | 57.6 | 46.1 | 38.4 | 28.8 |
| 15 | 18.0 | 13.5 | 10.8 | 9.0 | 6.8 | 65 | 78.0 | 58.5 | 46.8 | 39.0 | 29.3 |
| 16 | 19.2 | 14.4 | 11.5 | 9.6 | 7.2 | 66 | 79.2 | 59.4 | 47.5 | 39.6 | 29.7 |
| 17 | 20.4 | 15.3 | 12.2 | 10.2 | 7.7 | 67 | 80.4 | 60.3 | 48.2 | 40.2 | 30.2 |
| 18 | 21.6 | 16.2 | 13.0 | 10.8 | 8.1 | 68 | 81.6 | 61.2 | 49.0 | 40.8 | 30.6 |
| 19 | 22.8 | 17.1 | 13.7 | 11.4 | 8.6 | 69 | 82.8 | 62.1 | 49.7 | 41.4 | 31.1 |
| 20 | 24.0 | 18.0 | 14.4 | 12.0 | 9.0 | 70 | 84.0 | 63.0 | 50.4 | 42.0 | 31.5 |
| 21 | 25.2 | 18.9 | 15.1 | 12.6 | 9.5 | 71 | 85.2 | 63.9 | 51.1 | 42.6 | 32.0 |
| 22 | 26.4 | 19.8 | 15.8 | 13.2 | 9.9 | 72 | 86.4 | 64.8 | 51.8 | 43.2 | 32.4 |
| 23 | 27.6 | 20.7 | 16.6 | 13.8 | 10.4 | 73 | 87.6 | 65.7 | 52.6 | 43.8 | 32.9 |
| 24 | 28.8 | 21.6 | 17.3 | 14.4 | 10.8 | 74 | 88.8 | 66.6 | 53.3 | 44.4 | 33.3 |
| 25 | 30.0 | 22.5 | 18.0 | 15.0 | 11.3 | 75 | 90.0 | 67.5 | 54.0 | 45.0 | 33.8 |
| 26 | 31.2 | 23.4 | 18.7 | 15.6 | 11.7 | 76 | 91.2 | 68.4 | 54.7 | 45.6 | 34.2 |
| 27 | 32.4 | 24.3 | 19.4 | 16.2 | 12.2 | 77 | 92.4 | 69.3 | 55.4 | 46.2 | 34.7 |
| 28 | 33.6 | 25.2 | 20.2 | 16.8 | 12.6 | 78 | 93.6 | 70.2 | 56.2 | 46.8 | 35.1 |
| 29 | 34.8 | 26.1 | 20.9 | 17.4 | 13.1 | 79 | 94.8 | 71.1 | 56.9 | 47.4 | 35.6 |
| 30 | 36.0 | 27.0 | 21.6 | 18.0 | 13.5 | 80 | 96.0 | 72.0 | 57.6 | 48.0 | 36.0 |
| 31 | 37.2 | 27.9 | 22.3 | 18.6 | 14.0 | 81 | 97.2 | 72.9 | 58.3 | 48.6 | 36.5 |
| 32 | 38.4 | 28.8 | 23.0 | 19.2 | 14.4 | 82 | 98.4 | 73.8 | 59.0 | 49.2 | 36.9 |
| 33 | 39.6 | 29.7 | 23.8 | 19.8 | 14.9 | 83 | 99.6 | 74.7 | 59.8 | 49.8 | 37.4 |
| 34 | 40.8 | 30.6 | 24.5 | 20.4 | 15.3 | 84 | 100.8 | 75.6 | 60.5 | 50.4 | 37.8 |
| 35 | 42.0 | 31.5 | 25.2 | 21.0 | 15.8 | 85 | 102.0 | 76.5 | 61.2 | 51.0 | 38.3 |
| 36 | 43.2 | 32.4 | 25.9 | 21.6 | 16.2 | 86 | 103.2 | 77.4 | 61.9 | 51.6 | 38.7 |
| 37 | 44.4 | 33.3 | 26.6 | 22.2 | 16.7 | 87 | 104.4 | 78.3 | 62.6 | 52.2 | 39.2 |
| 38 | 45.6 | 34.2 | 27.4 | 22.8 | 17.1 | 88 | 105.6 | 79.2 | 63.4 | 52.8 | 39.6 |
| 39 | 46.8 | 35.1 | 28.1 | 23.4 | 17.6 | 89 | 106.8 | 80.1 | 64.1 | 53.4 | 40.1 |
| 40 | 48.0 | 36.0 | 28.8 | 24.0 | 18.0 | 90 | 108.0 | 81.0 | 64.8 | 54.0 | 40.5 |
| 41 | 49.2 | 36.9 | 29.5 | 24.6 | 18.5 | 91 | 109.2 | 81.9 | 65.5 | 54.6 | 41.0 |
| 42 | 50.4 | 37.8 | 30.2 | 25.2 | 18.9 | 92 | 110.4 | 82.8 | 66.2 | 55.2 | 41.4 |
| 43 | 51.6 | 38.7 | 31.0 | 25.8 | 19.4 | 93 | 111.6 | 83.7 | 67.0 | 55.8 | 41.9 |
| 44 | 52.8 | 39.6 | 31.7 | 26.4 | 19.8 | 94 | 112.8 | 84.6 | 67.7 | 56.4 | 42.3 |
| 45 | 54.0 | 40.5 | 32.4 | 27.0 | 20.3 | 95 | 114.0 | 85.5 | 68.4 | 57.0 | 42.8 |
| 46 | 55.2 | 41.4 | 33.1 | 27.6 | 20.7 | 96 | 115.2 | 86.4 | 69.1 | 57.6 | 43.2 |
| 47 | 56.4 | 42.3 | 33.8 | 28.2 | 21.2 | 97 | 116.4 | 87.3 | 69.8 | 58.2 | 43.7 |
| 48 | 57.6 | 43.2 | 34.6 | 28.8 | 21.6 | 98 | 117.6 | 88.2 | 70.6 | 58.8 | 44.1 |
| 49 | 58.8 | 44.1 | 35.3 | 29.4 | 22.1 | 99 | 118.8 | 89.1 | 71.3 | 59.4 | 44.6 |

Duty Cycle %/Dwell

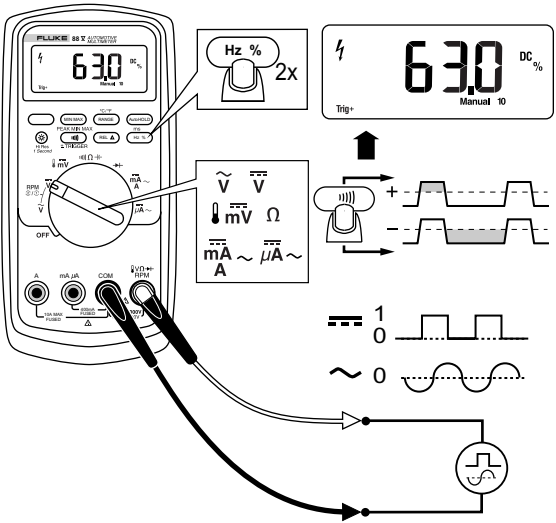

Frequency (Hz)

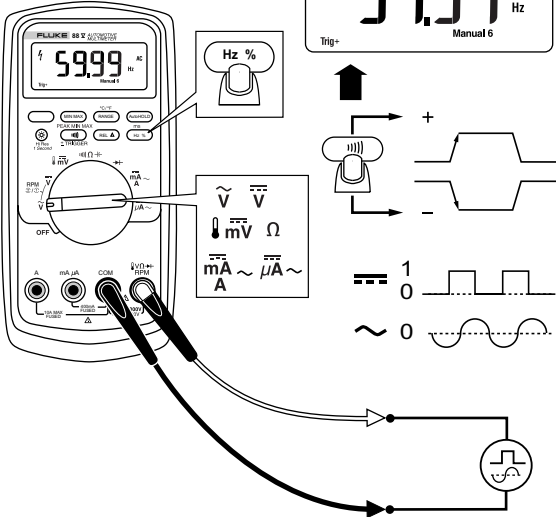

Pulse Width (ms)

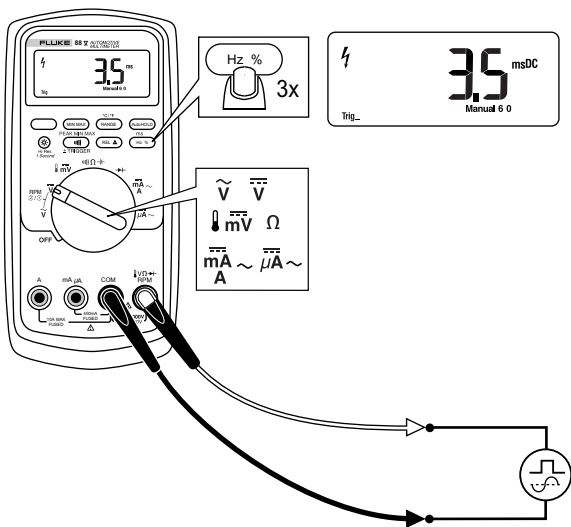

RPM 2/1

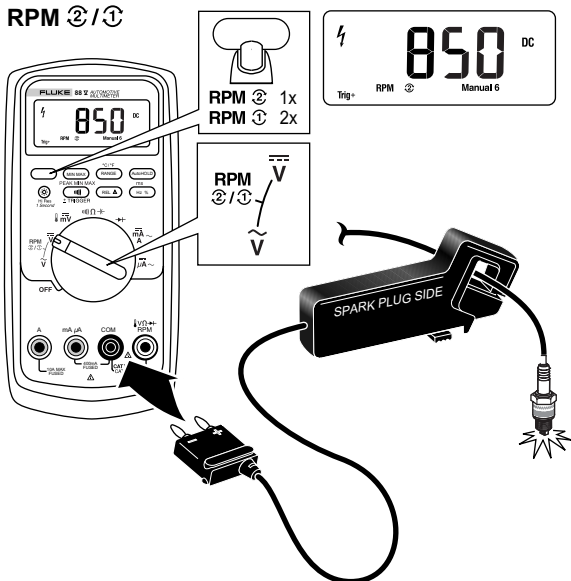

Min, Max, Average **MIN MAX**

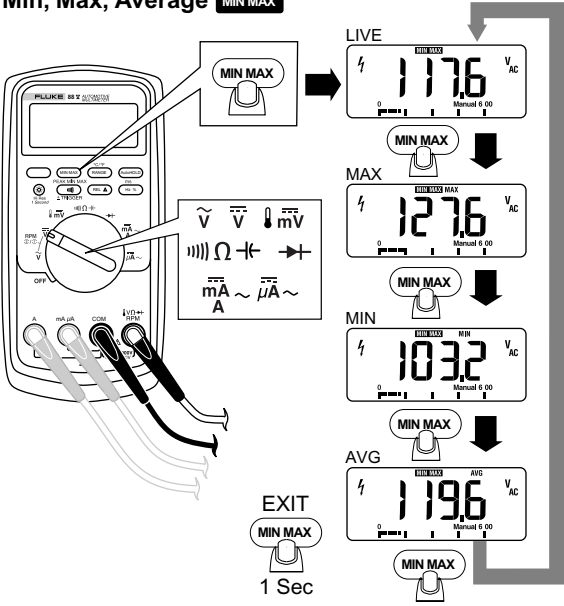

AutoHOLD **HOLD**

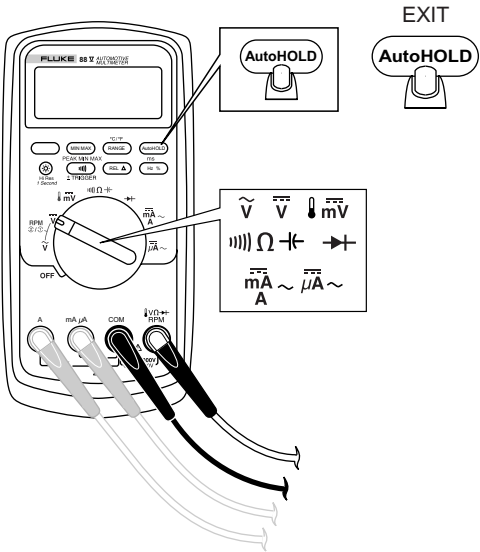

Relative Δ (Zero)

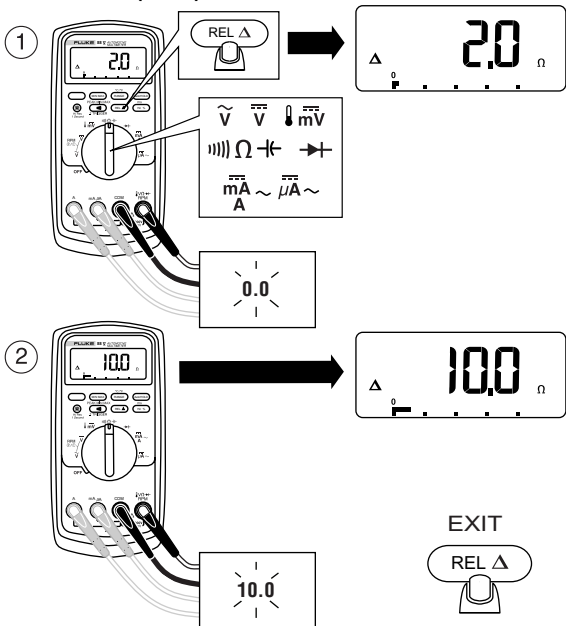

Hi Res Mode

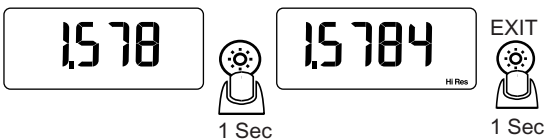

ToolPak

